

Processes



Oxy-Fuel

Soldering
Welding
Heating

The Little Torch®

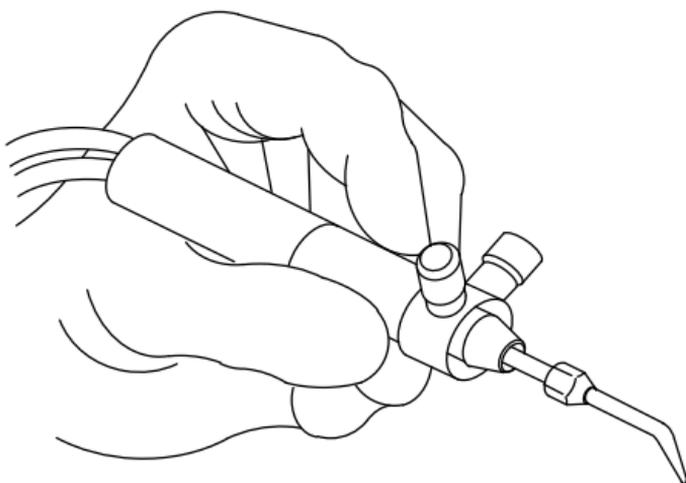

OWNERS MANUAL

File: Accessory



TABLE OF CONTENTS

SECTION 1 – SAFETY PRECAUTIONS - READ BEFORE USING	1
1-1. Symbol Usage	1
1-2. Oxy-Fuel Welding, Cutting, Brazing, Heating Hazards	1
1-3. California Proposition 65 Warnings	5
1-4. Principal Safety Standards	6
SECTION 2 – INTRODUCTION	7
SECTION 3 – HAZARDOUS EVENTS	7
SECTION 4 – HAZARDS OF RECOMPRESSING PURE OXYGEN	7
SECTION 5 – THE TORCH SYSTEM	8
5-1. Torch	8
5-2. Gases	8
5-3. Tips	8
5-4. Repairs/Replacement Of Hose	8
SECTION 6 – FREQUENTLY ASKED QUESTIONS	9
SECTION 7 – USING TORCH WITH DISPOSABLE-TYPE CYLINDERS	10
7-1. Disposable Compressed Gas Cylinders	11
7-2. Installing Regulators On Cylinders – Models 239-499B And 239-500B	11
7-3. Installing Hoses	11
7-4. Activating The System	12
7-5. Purging The System	12
7-6. Testing The Equipment For Leaks	12
7-7. Selecting And Installing A Tip	12
7-8. Lighting Procedures (When Using Disposable Cylinders)	12
7-9. Extinguishing The Torch Flame	13
7-10. Shutting Down The System	13
7-11. Bleeding The System	13
SECTION 8 – USING TORCH WITH HIGH PRESSURE CYLINDERS	13
8-1. Industrial-Type Cylinder Information	13
8-2. Installing Regulators	14
8-3. Installing Hoses	14
8-4. Activating The Regulators	14
8-5. Adjusting Regulator Pressures And Purging The Hoses	15
8-6. Testing The Equipment For Leaks	15
8-7. Selecting And Installing A Tip	16
8-8. Lighting /Adjusting Torch When Using Acetylene Or Hydrogen Fuel	16
8-9. Lighting And Adjusting Torch When Using Alternate Fuel Gases	17
8-10. Extinguishing The Torch Flame And Securing Equipment	17
8-11. Shutting Down The System	17
8-12. Bleeding The System Of Gases	17
SECTION 9 – HOSE REPLACEMENT	18
9-1. Removing Old Hose	18
9-2. Installing New Hose	18
SECTION 10 – REGULATORS	19
SECTION 11 – TECHNICAL DATA	20
11-1. Tip Specifications	20
11-2. Fuel Gas And Flame Characteristics	21
11-3. Flame And Heat Placement BTU Output Per Cubic Ft Of Fuel Burned	21
11-4. Cylinder Valve Identification For Regulator Selection	21
SECTION 12 – ACCESSORIES	22
WARRANTY	

SECTION 1 – SAFETY PRECAUTIONS - READ BEFORE USING

OXY FUEL 2013-06

-  Protect yourself and others from injury — read, follow, and save these important safety precautions and operating instructions.

1-1. Symbol Usage

-  **DANGER!** – Indicates a hazardous situation which, if not avoided, will result in death or serious injury. The possible hazards are shown in the adjoining symbols or explained in the text.
-  Indicates a hazardous situation which, if not avoided, could result in death or serious injury. The possible hazards are shown in the adjoining symbols or explained in the text.

NOTICE – Indicates statements not related to personal injury.

 Indicates special instructions.



This group of symbols means Warning! Watch Out! **ELECTRIC SHOCK, MOVING PARTS, and HOT PARTS** hazards. Consult

symbols and related instructions below for necessary actions to avoid the hazards.

1-2. Welding, Cutting, Brazing, Heating Hazards

-  The symbols shown below are used throughout this manual to call attention to and identify possible hazards. When you see the symbol, watch out, and follow the related instructions to avoid the hazard. The safety information given below is only a summary of the more complete safety information found in the Safety Standards listed in Section 1-4. Read and follow all Safety Standards.
-  Only qualified persons should install, operate, maintain, and repair this equipment.
-  During operation, keep everybody, especially children, away.
-  Do not use this equipment unless you are trained in its proper use or are under competent supervision. Follow the procedures described in this booklet every time you use the equipment. Failure to follow these instructions may cause fire, explosion, asphyxiation, property damage, or personal injury. This equipment must be used in accordance with all Federal, State, and local regulations as well as DOT (Department of Transportation) and CGA (Compressed Gas Association) regulations. Contact your gas supplier for more information on the proper use of compressed gases.

 In this document, the phrase “welding and cutting” also refers to other oxy-fuel operations like brazing and heating.



READ INSTRUCTIONS.

- Read and follow all labels and the Owner's Manual carefully before installing, operating, or servicing equipment. Read the safety information at the beginning of the manual and in each section.
- Use only genuine replacement parts from the manufacturer.
- Perform maintenance and service according to the Owner's Manuals, industry standards, and national, state, and local codes.



HOT PARTS can burn.

- Do not touch hot parts bare handed.
- Allow cooling period before working on equipment.
- To handle hot parts, use proper tools and/or wear heavy, insulated welding gloves and clothing to prevent burns.



FUMES AND GASES can be hazardous.

Welding and cutting produces fumes and gases. Breathing these fumes and gases can be hazardous to your health.

- Keep your head out of the fumes. Do not breathe the fumes.
- If inside, ventilate the area and/or use local forced ventilation at the flame to remove welding and cutting fumes and gases. Some gases (natural gas and acetylene) are lighter than air and will collect in high areas. Other gases (propane and butane) are heavier than air and will collect in low areas. Heavier-than-air gases are more difficult to diffuse and are more likely to accumulate.
- If ventilation is poor, wear an approved air-supplied respirator.
- Read and understand the Material Safety Data Sheets (MSDSs) and the manufacturer's instructions for metals, consumables, coatings, cleaners, and degreasers.
- Work in a confined space only if it is well ventilated, or while wearing an air-supplied respirator. Always have a trained watch-person nearby. Welding and cutting fumes and gases can displace air and lower the oxygen level, causing injury or death. Be sure the breathing air is safe. Test atmospheres in confined areas for explosive and toxic gases before using oxy-fuel equipment.
- Do not weld or cut in locations near degreasing, cleaning, or spraying operations. The heat from welding or cutting flame can react with vapors to form highly toxic and irritating gases.
- Do not weld or cut on coated metals, such as galvanized, lead, or cadmium-plated steel unless the coating is removed from the affected area, the area is well ventilated, and while wearing an air-supplied respirator. The coatings and any metals containing these elements can give off toxic fumes if welded or cut.
- Do not weld or cut on sealed air conditioning or refrigeration systems unless all refrigerants have been removed from the system.



BUILDUP OF GAS can injure or kill.

- Shut off compressed gas supply when not in use.
- Always ventilate confined spaces or use approved air-supplied respirator.



LIGHT RAYS can burn eyes and skin.

Light rays from the welding and cutting process produce intense visible and invisible (ultraviolet and infrared) rays that can burn eyes and skin. Sparks fly off from the weld.

- Wear approved face protection fitted with a proper shade of filter lenses to protect your face and eyes from light rays and sparks when welding, cutting, or watching (see ANSI Z49.1 and Z87.1 listed in Safety Standards).
- Wear welding goggles, or wear welding helmet/welding face-shield over approved goggles/safety glasses with side shields.
- Use protective screens or barriers to protect others from flash, glare and sparks; warn others not to watch the welding or cutting.
- Wear protective clothing made from durable, flame-resistant material (leather, heavy cotton, or wool) and foot protection.



WELDING AND CUTTING can cause fire or explosion.

Welding and cutting on closed containers, such as tanks, drums, or pipes, can cause them to blow up. Sparks can fly off from the welding or cutting operations. The flying sparks, hot workpiece, and hot equipment can cause fires and burns. Check and be sure the area is safe before doing any welding or cutting.

- Do not use this welding and cutting equipment with gases and pressures other than those for which it is intended. Oxygen is not flammable; however, the presence of pure oxygen will drastically increase the speed and force with which burning takes place. Oxygen must never be allowed to contact grease, oil, or other petroleum-based substances; therefore, be sure there is no oil or grease on the regulator, cylinder, valves, or equipment. Do not use petroleum-based pipe sealants. Do not use or store near excessive heat (above 125° F/51.5° C) or open flame. Do not refer to oxygen as air and do not use oxygen as a substitute for compressed air. Do not use oxygen to clean clothes or work area, for ventilation, or to operate pneumatic tools. Open oxygen cylinder valves slowly. Be sure regulator adjusting handle is in the full out (off) position before opening oxygen cylinder valve.
- Inspect all equipment before use. Do not use damaged, defective, or improperly adjusted welding and cutting equipment. Make sure levers and valves work properly, threads on equipment are clean (no grease or oil) and not deformed, gauges are intact and easy to read, regulator is clean and free of oil or dirt, and fittings are properly sized for the cylinder. Make sure hoses are clean (no grease or oil) and ferrules are properly installed so the fitting does not slip inside the hose. Be sure all connections are tight.
- It is recommended that a reverse-flow check valve or a flashback arrestor be installed between the torch handle and the regulator. Check valves do not prevent the propagation of a flame upstream (flashback) but are designed to prevent the unintentional backflow of gases into the cutting attachment, torch, hoses, or regulator which could cause an explosion or fire. A flashback arrestor can be installed on the torch handle instead of a check valve. Miller flashback arrestors have a reverse flow check valve and prevent the propagation of a flame upstream. If a flashback arrestor is installed, a check valve is not necessary. Using a flashback arrestor and a check valve may reduce gas flow and affect torch operation. To help prevent the reverse flow of gases, be sure the cylinders contain enough gas to complete the work.

- Perform work only in an area with a fireproof floor (concrete). Do not heat concrete because it may expand and explode violently.
- Perform work on a fireproof surface. Use heat resistant shields to protect nearby walls and flooring.
- Do not use if grease or oil is present on equipment or if equipment is damaged. Have equipment cleaned/repaired by a qualified person.
- Do not open a cylinder valve quickly or the regulator may be damaged and cause a fire.
- Do not open acetylene cylinder valve more than 3/4 turn. (For all gases except acetylene, open cylinder valve fully to backseat the cylinder valve.) Keep cylinder wrench on the cylinder for quick shut-off.
- Do not slightly open or "crack" acetylene cylinder valve to blow debris from the valve outlet. Remove the debris using nitrogen, air, or a clean, oil-free rag.
- Always purge gas from the system before lighting torch. Purge gas in a well-ventilated area and away from flame or sparks.
- Keep torch flame or sparks away from cylinder, regulator, and gas hose.
- Use only the gases recommended by the manufacturer of the oxy-fuel equipment being used.
- Never light a torch with matches or a lighter. Always use a striker.
- Do not use acetylene above 15 psi (103 kPa) flowing. It is acceptable to use acetylene regulators that indicate a static pressure up to 22 psi (151 kPa).
- Check oxy-fuel system for leaks with an approved leak detection solution or leak detector. Never test for gas leaks with a flame.
- Remove all flammables within 35 ft (10.7 m) of the welding or cutting operation. If this is not possible, tightly cover them with approved covers.
- Do not weld or cut where flying sparks can strike flammable material.
- Protect yourself and others from flying sparks and hot metal.
- Be alert that welding and cutting sparks and hot materials from welding and cutting can easily go through small cracks and openings to adjacent areas.
- Watch for fire, and keep a fire extinguisher nearby.
- Be aware that welding or cutting on a ceiling, floor, bulkhead, or partition can cause fire on the hidden side.
- Do not weld or cut on containers that have held combustibles, or on closed containers such as tanks, drums, or pipes unless they are properly prepared according to AWS F4.1 and AWS A6.0 (see Safety Standards).
- Do not weld or cut where the atmosphere may contain flammable dust, gas, or liquid vapors (such as gasoline).
- Wear oil-free protective garments such as leather gloves, heavy shirt, cuffless trousers, high shoes, and a cap.
- Do not use fuel gases to clean clothes or work area.
- Remove any combustibles, such as a butane lighter or matches, from your person before doing any welding or cutting.
- After completion of work, inspect area to ensure it is free of sparks, glowing embers, and flames.
- Follow requirements in OSHA 1910.252 (a) (2) (iv) and NFPA 51B for hot work and have a fire watcher and extinguisher nearby.



CYLINDERS can explode if damaged.

Compressed gas cylinders contain gas under high pressure. If damaged, a cylinder can explode. Since gas cylinders are normally part of the welding or cutting process, be sure to treat them carefully.

- Protect compressed gas cylinders from excessive heat, mechanical shocks, physical damage, slag, open flames, and sparks.
- Install cylinders in an upright position by securing to a stationary support or cylinder rack to prevent falling or tipping. Do not lay acetylene cylinders on their sides or acetone will flow out of the cylinder and damage the equipment.
- Keep cylinders away from any arc welding, cutting, or other electrical circuits.
- Never drape a welding or cutting torch over a gas cylinder.
- Never weld or cut on a pressurized cylinder – explosion will result.
- Use only correct compressed gas cylinders, regulators, hoses, and fittings designed for the specific application; maintain them and associated parts in good condition. Do not use compressed gas cylinder unless an approved gas regulator is attached to the gas valve.
- Turn face away from valve outlet when opening cylinder valve. Do not stand in front of or behind the regulator when opening the valve.
- Keep protective cap in place over valve except when cylinder is in use or connected for use.
- Use the right equipment, correct procedures, and sufficient number of persons to lift and move cylinders.
- Store compressed gas and oxygen cylinders in separate locations.
- Store empty cylinders with valves closed and caps in place.
- Do not modify or repair cylinders or valves. Store leaking acetylene cylinders outdoors in a safe area. Identify leaking cylinders and return them to the supplier.
- Dispose of used disposable cylinders according to the manufacturer's recommendations. Do not throw cylinders in fire.
- Follow instructions provided by the gas supplier and on compressed gas cylinders, associated equipment, and in Compressed Gas Association (CGA) publication P-1 listed in Safety Standards.



FLYING METAL or DIRT can injure eyes.

- Welding, cutting, chipping, wire brushing, and grinding cause sparks and flying metal.
- Wear welding goggles, or wear welding helmet/welding face-shield over approved goggles/safety glasses with side shields.

1-3. California Proposition 65 Warnings



Welding or cutting equipment produces fumes or gases which contain chemicals known to the State of California to cause birth defects and, in some cases, cancer. (California Health & Safety Code Section 25249.5 et seq.)



This product contains chemicals, including lead, known to the state of California to cause cancer, birth defects, or other reproductive harm. *Wash hands after use.*

1-4. Principal Safety Standards

Safety in Welding, Cutting, and Allied Processes, ANSI Standard Z49.1, is available as a free download from the American Welding Society at <http://www.aws.org> or purchased from Global Engineering Documents (phone: 1-877-413-5184, website: www.global.ihs.com).

Safe Practices for the Preparation of Containers and Piping for Welding and Cutting, American Welding Society Standard AWS F4.1, from Global Engineering Documents (phone: 1-877-413-5184, website: www.global.ihs.com).

Safe Practices for Welding and Cutting Containers that have Held Combustibles, American Welding Society Standard AWS A6.0, from Global Engineering Documents (phone: 1-877-413-5184, website: www.global.ihs.com).

Safe Handling of Compressed Gases in Cylinders, CGA Pamphlet P-1, from Compressed Gas Association, 14501 George Carter Way, Suite 103, Chantilly, VA 20151 (phone: 703-788-2700, website: www.cganet.com).

Acetylene, CGA Pamphlet G-1, from Compressed Gas Association, 14501 George Carter Way, Suite 103, Chantilly, VA 20151 (phone: 703-788-2700, website: www.cganet.com).

Safety in Welding, Cutting, and Allied Processes, CSA Standard W117.2, from Canadian Standards Association, Standards Sales, 5060 Spectrum Way, Suite 100, Ontario, Canada L4W 5NS (phone: 800-463-6727, website: www.csa-international.org).

Safe Practice For Occupational And Educational Eye And Face Protection, ANSI Standard Z87.1, from American National Standards Institute, 25 West 43rd Street, New York, NY 10036 (phone: 212-642-4900, website: www.ansi.org).

Standard for Fire Prevention During Welding, Cutting, and Other Hot Work, NFPA Standard 51B, from National Fire Protection Association, Quincy, MA 02269 (phone: 1-800-344-3555, website: www.nfpa.org).

OSHA, Occupational Safety and Health Standards for General Industry, Title 29, Code of Federal Regulations (CFR), Part 1910, Subpart Q, and Part 1926, Subpart J, from U.S. Government Printing Office, Superintendent of Documents, P.O. Box 371954, Pittsburgh, PA 15250-7954 (phone: 1-866-512-1800) (there are 10 OSHA Regional Offices—phone for Region 5, Chicago, is 312-353-2220, website: www.osha.gov).

Applications Manual for the Revised NIOSH Lifting Equation, The National Institute for Occupational Safety and Health (NIOSH), 1600 Clifton Rd, Atlanta, GA 30333 (phone: 1-800-232-4636, website: www.cdc.gov/NIOSH).

Recommended Practices for Safe Oxyfuel Gas Cutting Torch Operation C4.2/C4.2M, and Recommended Practices for Safe Oxyfuel Gas Heating Torch Operation C4.3/C4.3M from Global Engineering Documents (phone: 1-877-413-5184, website: www.global.ihs.com).

SECTION 2 – INTRODUCTION



⚠ Inspect all equipment before use. Do not use damaged, defective, or improperly adjusted welding and cutting equipment. Make sure levers and valves work properly, threads on equipment are clean (no grease or oil) and not deformed, gauges are intact and easy to read, regulator is clean and free of oil or dirt, and fittings are properly sized for the cylinder. Make sure hoses are clean (no grease or oil) and ferrules are properly installed so the fitting does not slip inside the hose. Be sure all connections are tight and there are no leaks in the system.

This booklet offers basic information regarding the Little Torch. Given reasonable care, the torch will provide trouble-free use for many years.

SECTION 3 – HAZARDOUS EVENTS

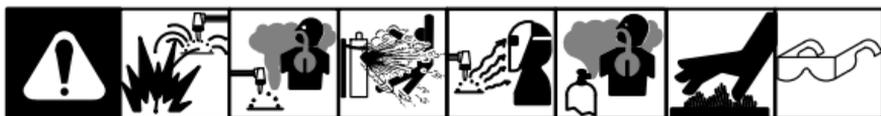

The following events are very hazardous and can occur in any oxy-fuel system. It is important to understand these hazards and know how to prevent them.

Backfire: The return of the flame into the torch, usually accompanied by a popping sound. The flame may be extinguished or it may re-appear at the tip end.

Sustained Backfire: The return of the flame into the torch that continues to burn inside the torch with a hissing or squealing sound.

Flashback: The return of a flame into and through the torch or into the hose. In some instances it can reach the regulator and even enter the cylinder. This is generally caused by the mixing of the oxygen and fuel gas in the system. This is a very dangerous situation that can cause an explosion anywhere in the system. This is why purging is so important (Section 7-5 or 8-5).

SECTION 4 – ASSOCIATED HAZARDS OF RECOMPRESSING PURE OXYGEN



⚠ Open oxygen cylinder valves slowly. Opening an oxygen cylinder valve quickly can cause a fire or explosion. Be sure regulator adjusting handle is in the full out (off) position before opening an oxygen cylinder valve.

Recompressing high pressure oxygen in a low pressure cavity may create heat, resulting in combustion. For combustion to occur, oxygen, fuel, and kindling temperatures must be present. All of these components may be present when oxygen is recompressed by opening the tank valve too quickly.

Oxygen: High purity oxygen accelerates the rate of combustion, increases heat output, and lowers the combustible point at which various materials will burn.

Fuel: The fuel for combustion may be the regulator itself if enough heat is produced to reach the kindling temperature of the regulator's components.

Kindling Temperatures: Enough heat may be generated to ignite the regulator components by the friction created when recompressing high-pressure oxygen. This heat is known as the heat of recompression.

⚠ If an internal fire or flashback occurs (indicated by a whistling sound or inverted flame), do the following:

- Turn off the torch oxygen valve immediately.
- Turn off the torch fuel valve.
- Turn off the oxygen cylinder valve.
- Turn off the fuel gas cylinder valve.

Do not relight the torch until the equipment has cooled to the touch and the flashback cause has been determined and corrected.

SECTION 5 – THE TORCH SYSTEM



5-1. Torch

The torch is designed to meet the requirements of industry for a small, lightweight torch to fusion weld, braze, heat, and solder materials ranging from 3/16 in. (5 mm) metal to ultra-fine wires. The six tips available provide a wide range of flame sizes and the versatility to perform many different tasks. Lightweight construction and highly flexible hose provide pinpoint welding with maximum control.

5-2. Gases

The torch uses oxygen and these commonly available pressurized fuel gases: acetylene, hydrogen, propane, propylene, or natural gas. The smallest tip (size 2) can only be used satisfactorily with acetylene and hydrogen fuel gases.

NOTICE – When using natural gas, a minimum of 1 psig (6.9 kPa) is required at the torch. Higher pressures are necessary for use with melting tips.

5-3. Tips

There are six tips available for the torch. Because of their extraordinarily small orifices, tip sizes 2 and 3 are fitted with a synthetic sapphire to ensure accurate gas flow. There are also two different heating tips available, one tip is for use with acetylene or hydrogen and another tip is designed for propane or natural gas. Refer to the pressure recommendation chart provided in this booklet for the tips being used.

5-4. Repairs/Replacement Of Hose

- ⚠** Replace hoses at the first sign of any defects, flaws, or damage. The hoses should otherwise be replaced every four years. Inspect hoses for damage or leaks before each operation. Do not allow hoses to come in contact with hot metal, molten solder, or corrosive chemicals. Do not expose hoses to fluxing agents as these agents will deteriorate the hose materials and cause them to leak.
- ⚠** Use an approved oil-free leak detection fluid to locate possible leaks.

⚠ Use only industrial grade hose. Grade T hose is acceptable for all fuel gases. Grade R hose is for acetylene only.

The torch hose is of a special material designed to be compatible with the various fuel gases. The maximum length of hose used should not exceed 12 ft (3.7 m). The hose may be attached to standard welding gas hoses 3/16 in. or larger diameter with special brass fittings if the gas cylinders must be located a further distance from the torch. The brass B-type fittings for connecting the hoses can be purchased from most welding equipment dealers.

For your protection, use only genuine Smith Equipment hose and replacement parts. Smith Equipment replacement hoses come with step-by-step replacement instructions and a tool for securing the brass ferrules over the hose ends.

Repairs and replacement parts are available through your authorized Smith Equipment distributor. Find a dealer at www.smithequipment.com.

SECTION 6 – FREQUENTLY ASKED QUESTIONS



How do I replace the torch hose?

Step-by-step instructions, a ferrule (brass hose retainer band), and ferrule replacement tool accompany all replacement hose assemblies.

What are the part numbers for replacement hose assemblies?

- Oxygen 13254-1-8
- Fuel Gas 13254-3-8
- Hose Pair 13254-4-8

Why is it hard to light size 1 and size 2 tips or keep them lit?

This condition is typically due to excessive gas pressures. A maximum of just 2 psig (13.7 kPa) outlet pressure is recommended for both gases and the use of an open flame makes lighting the tiny flames much easier.

Does the torch require adaptors to fit cylinder regulators?

For most regulators the answer is no. The hose assemblies have standard size B, 9/16 in. welding hose-type connections and will attach to most industrial welding gas regulators.

Can the orifices in the torch tips be cleaned?

If the orifices are obstructed by flux, the tips can often be cleaned by boiling them in water for about 10 minutes. Other methods used to clean dirty tips involve the use of a jeweler's type steam cleaner or an ultrasonic cleaner.

What fuel gases will work with the torch?

The torch may be operated with most commercially used welding gases including acetylene, propane, hydrogen, propylene, and butane. It may also be used with city gas (natural gas) at a minimum pressure of 1 psig (6.9 kPa) at the torch.

NOTICE – Most city gas lines only produce 1/4–1/2 psig (1.7–3.4 kPa).

What fuel gas should I use with the torch?

Most operators use either acetylene or propane. However both gases offer specific advantages and disadvantages. Acetylene produces a very

concentrated, pinpoint high temperature flame (about 6000°F/3316°C) whereas the other gases tend to spread the heat produced throughout the outer flame. The acetylene flame produces soot during combustion and the LP gases tend to burn much cleaner. Acetylene gas is lighter than air and in the event of a gas leak it will tend to dissipate in the atmosphere with any air flow. LP gas is heavier than air and will collect in low spots, thereby creating potential breathing and combustion hazards.

What are the flame sizes and orifice diameters of the tips?

Tip Size	Orifice Diameter	Orifice Drill Size	BTUs/Hr	Recommended Pressures (Both Gases)		Overall Flame Length	
				psig	kPa	in.	mm
2	.006	97	130	2	13.7	1/8	3
3	.011	85	1,150	4	20.7	1-1/2	38
4	.020	76	2,300	5	27.6	5-1/2 (thin)	140
5	.029	69	3,800	6	34.5	5-1/2	140
6	.037	63	6,585	6	41.4	6-1/2	165
7	.047	56	9,200	8	48.3	7	178

What are the applications for twin flame tips?

The flexible twin flame tips may be used where both sides of an object can be heated. They can speed up the soldering or brazing process and provide even heating for complete, more even solder flows. The size 3 twin tip is often used by jewelers for sizing rings. Tip tubes are flexible and may be bent to position the flames as desired.

What are the applications for the multi-flame (rosebud) tips?

They may be used where a larger, more widely dispersed flame is needed for brazing, soldering, or heating. They are used predominantly in the jewelry industry for annealing, reticulation, and casting of gold and silver. Both acetylene and the propane models are capable of casting up to 3 oz (85 g) of gold or silver. These tips are also used for enameling and plastics polishing.

Can the torch gas valves be replaced if they are damaged or worn out?

Yes, the complete valve assembly may be replaced for either gas. Using an open end wrench, remove the valve assembly from the torch body. The white PTFE packing rings under the valves should also be replaced (part no. 7348). Valve assembly part numbers are as follows: oxygen (green) No. 7345; fuel (red) No.7346.

SECTION 7 – USING THE TORCH WITH DISPOSABLE-TYPE CYLINDERS



⚠ Inspect equipment before use. Do not use if grease or oil is present on equipment or if equipment is damaged. Have equipment cleaned/repared by a qualified person.

-  **Do not slightly open or “crack” acetylene cylinder valve to blow debris from the valve outlet. Remove the debris using nitrogen, air, or a clean, oil-free rag.**

7-1. Disposable Compressed Gas Cylinders

Use only compressed gas cylinders that are approved by the Department of Transportation (DOT) with this equipment. The torch will operate on the throw-away disposable cylinders that are found in most hardware, retail, or welding outlets.

-  **Dispose of used disposable cylinders according to the manufacturer’s recommendations. Do not throw cylinders in fire.**
-  **Do not completely empty disposable cylinders. When the flame indicates a loss of pressure, immediately shut down the system and replace the cylinder.**
-  **Never tamper with or attempt to repair disposable cylinders. If damaged, return cylinder to the supplier. Always check the regulator cylinder connection for leaks.**

7-2. Installing Regulators On Cylinders – Models 239-499B And 239-500B

1. Before attaching the regulators to the disposable cylinders, be sure the regulator and torch valves are in the Off position.
2. Attach the oxygen regulator (identified by the word “Oxygen” stamped on side of regulator) to the oxygen cylinder. The disposable oxygen cylinder and the oxygen regulator both have left-hand threads. Turn regulator by hand counterclockwise and tighten securely.
3. Attach the fuel gas regulator to the disposable fuel gas cylinder. The regulator and the cylinder both have right-hand threads. Turn regulator by hand clockwise and tighten securely.
4. Check the regulator–cylinder connection for leaks.

7-3. Installing Hoses

-  **Replace hoses at the first sign of any defects, flaws, or damage. The hoses should otherwise be replaced every four years. Inspect hoses for damage or leaks before each operation. Do not allow hoses to come in contact with hot metal, molten solder, or corrosive chemicals. Do not expose hoses to fluxing agents as these agents will deteriorate the hose materials and cause them to leak.**

-  **Do not splice or use damaged oxy-fuel hoses.**

1. Use only the hoses that are supplied by Smith Equipment. These hoses transport low-pressure gases from the regulator to the torch tips. The hoses are color coded (green) for oxygen and (red) for fuel gas.
2. Attach the green hose to the oxygen regulator (right-hand threads) and tighten firmly with a wrench.
3. Attach the red hose to the fuel gas regulator (left-hand threads) and tighten firmly with a wrench.

 *If the hoses are not color coded, attach the hose connection with machined grooves on the nut to the fuel gas regulator (left-hand threads). Attach the hose connection with no grooves on the nut to the oxygen regulator (right-hand threads). Tighten both connections firmly with a wrench.*

4. Close both the oxygen and fuel gas valves on torch body.

7-4. Activating The System

Open the regulator valves completely by turning knobs clockwise. Notice the arrows on top of the knobs.

7-5. Purging The System

⚠ Always purge gas from the system before lighting torch to prevent a possible mixed-gas explosion. Purge gas in a well ventilated area and away from flame or sparks.

1. With the tip removed from the torch, open the torch oxygen valve for 3–4 seconds to purge line.
2. Close the torch oxygen valve.
3. Repeat steps 1 and 2 for the fuel gas.

7-6. Testing The Equipment For Leaks

⚠ Use an approved oil-free leak detection fluid to locate possible leaks.

⚠ Do not stand in front of or behind the regulator when opening the cylinder valve. Never open a cylinder valve suddenly as this can damage a regulator or cause an oxygen regulator fire.

With the system pressurized and the torch body valves closed, check every connection and joint from the cylinder valve to the torch tip with an approved leak detection solution (Figure 1). If leaks are detected, eliminate them before proceeding. If leaks cannot be eliminated, do not put the equipment into service until it has been repaired or replaced.

☞ If the torch is not going to be in use for more than one half hour, turn the regulator valves to the Off position.



161-013

Figure 1. Testing Equipment For Leaks

7-7. Selecting And Installing A Tip

1. Fully open the oxygen and fuel gas regulators (turn handles clockwise).
2. Select the desired tip. Tip sizes are represented by a number (2–7) stamped on the copper section. Size 7 produces the largest flame.

☞ It is recommended that the size 2 tip not be used for gas other than acetylene or hydrogen.

3. Install tip and tighten with a wrench. (Do not overtighten.)

7-8. Lighting Procedures (When Using Disposable Cylinders)

Follow the set-up instructions explained in Sections 7-2 thru 7-7 before lighting the torch.

⚠ When lighting torch, keep the tip pointed away from people and combustibles.

1. Open the torch fuel gas valve approximately 1/8–1/4 turn (counterclockwise) and Ignite the fuel gas using an approved friction spark lighter.

⚠ Do not use matches or a cigarette lighter to ignite the gas.

2. Slowly open the torch oxygen valve (counterclockwise) until the flame is neutralized. This is accomplished by adding oxygen until the bright cone off the end of the tip just reaches its shortest length.
3. Increase the fuel gas flow by opening torch valve another 1/8 turn.
4. Increase the oxygen until the flame is neutralized. If necessary, continue this procedure until the maximum volume of fuel and oxygen are being used and the desired flame is achieved.

7-9. Extinguishing The Torch Flame

1. Turn the fuel-gas torch valve to the closed position (clockwise).
2. Turn the torch oxygen valve to the closed position (clockwise).

7-10. Shutting Down The System

1. Extinguish torch flame (see Section 7-9).
2. Turn the oxygen regulator valve knob to the closed position (counterclockwise). Notice arrow on knob.
3. Turn the fuel gas regulator valve knob to the closed position (counterclockwise). Notice arrow on knob.

7-11. Bleeding The System

1. Remove the tip from the torch.
2. Open the torch oxygen valve 1/2 turn until all pressure has been released from the hose and regulator, then close the torch oxygen valve.
3. Open the torch fuel gas valve 1/2 turn until all pressure has been released from the hose and regulator, then close the torch fuel gas valve.
4. Secure equipment and store in safe area.

SECTION 8 – USING THE TORCH WITH HIGH PRESSURE, INDUSTRIAL-TYPE CYLINDERS

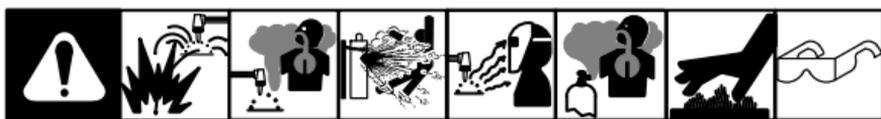

- ⚠ Install cylinders in an upright position by securing to a stationary support or cylinder rack to prevent falling or tipping. Maintain a clear path from the cylinders to the work area.**
- ⚠ Inspect equipment before use. Do not use if grease or oil is present on equipment or if equipment is damaged. Have equipment cleaned/repared by a qualified person.**
- ⚠ Do not slightly open or “crack” acetylene cylinder valve to blow debris from the valve outlet. Remove the debris using nitrogen, air, or a clean, oil-free rag.**

Use only compressed gas cylinders that are approved by the Department of Transportation (DOT) with this equipment. The torch will operate on cylinders that are available from Smith Equipment or from your local welding supply dealer.

8-1. Industrial-Type Cylinder Information

- Industrial oxygen cylinders are pressurized to approximately 2,250 psig (15,513 kPa)

- Industrial hydrogen cylinders are pressurized to approximately 2,250 psig (15,513 kPa).
- Industrial acetylene cylinders are pressurized to approximately 250 psig (1724 kPa)

8-2. Installing Regulators

Oxygen regulator is identified by green color and has right-hand threads for cylinder connection. Fuel gas regulator is identified by red color and has left-hand threads for cylinder connection.

1. Attach the oxygen regulator to the oxygen cylinder and tighten firmly with a wrench clockwise (right-hand threads). See Figure 2.

 Always tighten regulator connection nuts with a wrench.

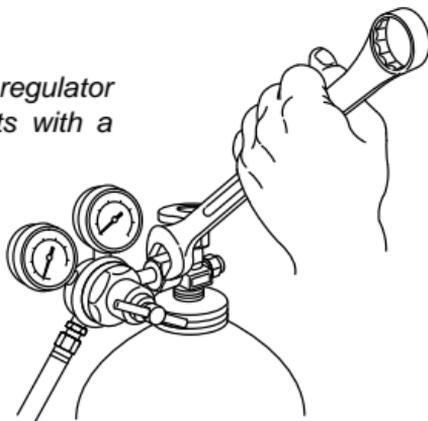

161-015

Figure 2. Installing Regulator

2. Attach the fuel gas regulator to the fuel gas cylinder and tighten firmly with a wrench counterclockwise (left-hand threads). Fuel gas regulators may have left or right hand threads. A regulator connection with machined grooves in the nut indicates the regulator has left-hand threads. If there are no machined grooves in the nut the regulator has right-hand threads (for use with MC or B acetylene cylinders).

8-3. Installing Hoses

 **Replace hoses at the first sign of any defects, flaws, or damage. The hoses should otherwise be replaced every four years. Inspect hoses for damage or leaks before each operation. Do not allow hoses to come in contact with hot metal, molten solder, or corrosive chemicals. Do not expose hoses to fluxing agents as these agents will deteriorate the hose materials and cause them to leak.**

 **Do not splice or use damaged oxy-fuel hoses.**

1. Use only the hoses that are supplied by Smith Equipment. These hoses transport low-pressure gases from the regulator to the torch tips. The hoses are color coded (green) for oxygen and (red) for fuel gas.
2. Attach the green hose to the oxygen regulator (right-hand thread) and tighten firmly with a wrench.
3. Attach the red hose to the fuel gas regulator (left-hand thread) and tighten firmly with a wrench.
4. Close both the oxygen and fuel gas valves on torch body.

8-4. Activating The Regulators

 **Do not stand in front of or behind the regulator when opening the cylinder valve. Never open a cylinder valve suddenly as this can damage a regulator or cause an oxygen regulator fire.**

⚠ Do not activate the system with the regulator pressure adjusting handle turned in. This condition can allow high pressure gas to damage the internal parts of the regulator which can result in a fire or explosion.

1. Turn the oxygen regulator pressure adjusting handle counterclockwise until no spring pressure is felt on the pressure adjusting handle.
2. Turn the fuel-gas regulator pressure adjusting handle counterclockwise until no spring pressure is felt on the pressure adjusting handle.
3. With the oxygen cylinder between you and the regulator, slowly open the cylinder valve until the maximum cylinder pressure is indicated on the high-pressure regulator gauge. Then, open the oxygen cylinder valve all the way.
4. Open cylinder valve. When using acetylene as the fuel gas, open cylinder valve no more than 3/4 turn. When using a fuel gas other than acetylene, open the cylinder valve completely.

8-5. Adjusting Regulator Pressures And Purging The Hoses

1. Verify the oxygen and fuel-gas valves on the torch body are in the closed (off) position.
2. Turn oxygen regulator pressure-adjusting handle clockwise until the low pressure gauge indicates 5 psig (34 kPa).

⚠ Always purge gas from the system before lighting torch to prevent a possible mixed-gas explosion. Purge gas in a well ventilated area and away from flame or sparks.

3. With no tip installed, open the torch body oxygen valve and allow oxygen to flow for three to four seconds. This will purge the oxygen side of the system.
4. Repeat steps 2 and 3 for the fuel gas. This will purge the fuel gas side of the system.

8-6. Testing The Equipment For Leaks

⚠ Use an approved oil-free leak detection fluid to locate possible leaks.

⚠ Do not stand in front of or behind the regulator when opening the cylinder valve. Never open a cylinder valve suddenly as this can damage a regulator or cause an oxygen regulator fire.

With the system pressurized and the torch body valves closed, check every connection and joint from the cylinder valve to the torch tip with an approved leak detection solution (Figure 3). If leaks are detected, eliminate them before proceeding. If leaks cannot be eliminated, do not put the equipment into service until it has been repaired or replaced.

📖 *If the torch is not going to be in use for more than one half hour, it is recommended that the system be completely shut down (see Section 8-11).*



161-013

Figure 3. Testing Equipment For Leaks

8-7. Selecting And Installing A Tip

1. Fully open the oxygen and fuel gas regulators (turn handles clockwise).
2. Select the desired tip. Tip sizes are represented by a number (2–7) stamped on the copper section. Size 7 produces the largest flame.

It is recommended that the size 2 tip not be used for gas other than acetylene or hydrogen.

3. Install tip and tighten with a wrench. (Do not overtighten.)

8-8. Lighting And Adjusting Torch When Using Acetylene Or Hydrogen Fuel Gas

The following instructions are adjustment procedures for the torch when using acetylene or hydrogen fuel gases. This equipment is designed to operate at a set volume of gas for each tip.

Follow the set-up instructions explained in Sections 8-2 thru 8-7 before lighting the torch.

⚠ Using less than the required volume of gas may result in overheating of the tip or equipment and can lead to an internal fire or flashback.

⚠ When lighting torch, keep the tip pointed away from people and combustibles.

When using hydrogen, the flame from the size 2 tip will be difficult to see. Lighting and flame adjustment should be made in a dark area or in front of a dark background. Use of a cobalt goggle lens may increase flame visibility.

1. Adjust the regulator outlet pressure to the torch by turning the regulator adjusting handle clockwise until the outlet pressure gauge indicates the recommended pressures for the tip being used (see Section 11-1).
2. Slightly open the torch fuel gas valve approximately 1/4 turn and ignite the gas using an approved friction spark lighter or bunsen burner.

⚠ Do not use matches or a cigarette lighter to ignite the gas.

3. Continue opening the fuel gas valve until the flame is about to leave the end of the tip or the soot being discharged disappears.
4. Slowly open the torch oxygen valve. Continue to open torch valve until the flame is in its neutral condition or the desired flame is achieved.

8-9. Lighting And Adjusting Torch When Using Alternate Fuel Gases (Propane, Propylene, Natural Gas)

The following instructions are adjustment procedures for the torch when using alternate fuel gases. This equipment is designed to operate at a set volume of gas for each tip.

Follow the set-up instructions explained in Sections 8-2 thru 8-7 before lighting the torch.

⚠ Using less than the required volume of gas may result in overheating of the tip or equipment and can lead to an internal fire or flashback.

⚠ When lighting torch, keep the tip pointed away from people and combustibles.

 Do not use the size 2 tip for alternate fuel gases. The size 3 tip may be difficult to light when using natural gas as the fuel.

1. Adjust the regulator outlet pressure to the torch by turning the regulator adjusting handle clockwise until the outlet pressure gauge indicates the recommended pressures for the tip being used (see Section 11-1).
2. Slightly open the torch fuel gas valve approximately 1/4 turn and ignite the gas using an approved friction spark lighter or bunsen burner.

⚠ Do not use matches or a cigarette lighter to ignite the gas.

3. Adjust until the flame is about to leave the end of tip.
4. Slowly open the torch oxygen valve until a neutral flame is obtained.
5. Further open the torch fuel valve 1/8–1/4 turn.
6. Again open the torch oxygen valve until the flame is neutral.
7. If needed, continue this procedure until the maximum volume of fuel and oxygen are being used and desired flame is achieved.

8-10. Extinguishing The Torch Flame And Securing Equipment

1. Turn the torch fuel gas valve to the closed position (clockwise).
2. Turn the torch oxygen valve to the closed position (clockwise).

8-11. Shutting Down The System

1. Extinguish torch flame (see Section 8-10).
2. Turn the oxygen cylinder valve to the closed position (clockwise).
3. Turn the fuel gas cylinder valve to the closed position (clockwise).

8-12. Bleeding The System Of Gases

1. Remove tip from torch body.
2. Open torch oxygen valve 1/2 turn.
3. Observe oxygen regulator. When low pressure gauge indicates zero (0), close the torch oxygen valve.
4. Turn the oxygen regulator pressure adjusting handle to the left (counterclockwise) until no spring pressure is felt on the adjusting handle.
5. Repeat steps 2, 3, and 4 for the fuel gas.
6. Secure equipment and store in safe area.

SECTION 9 – HOSE REPLACEMENT



- ⚠** Replace hoses at the first sign of any defects, flaws, or damage. The hoses should otherwise be replaced every four years. Inspect hoses for damage or leaks before each operation. Do not allow hoses to come in contact with hot metal, molten solder, or corrosive chemicals. Do not expose hoses to fluxing agents as these agents will deteriorate the hose materials and cause them to leak.
- ⚠** Use only industrial grade hose. Grade T hose is acceptable for all fuel gases. Grade R hose is for acetylene only.

 The following instructions apply only to the torch bodies in torch models 11-1101C, 11-1102C, 11-1103C, and 11-1104C. Check instructions per your specific torch body number as stamped on the black handle tube.

9-1. Removing Old Hose

1. Lock ferrule tool in vise. Insert tool between torch body and ferrule. See Figure 4.
2. Grasp torch firmly and pull forward. The ferrule will slide back on the hose. Repeat operation on second hose. Slide ferrule away from torch.
3. Remove hose from torch body.

9-2. Installing New Hose

1. Check that regulator right-hand thread nut is on green/blue hose and left-hand thread (grooved) nut is on red hose. Place new ferrule on each hose and slide ferrule down each hose 1–2 in. (25–51 mm).
2. Slide the green hose over the barbed nipple. Slip hose into ferrule tool below ferrule and slide tool against end of ferrule.

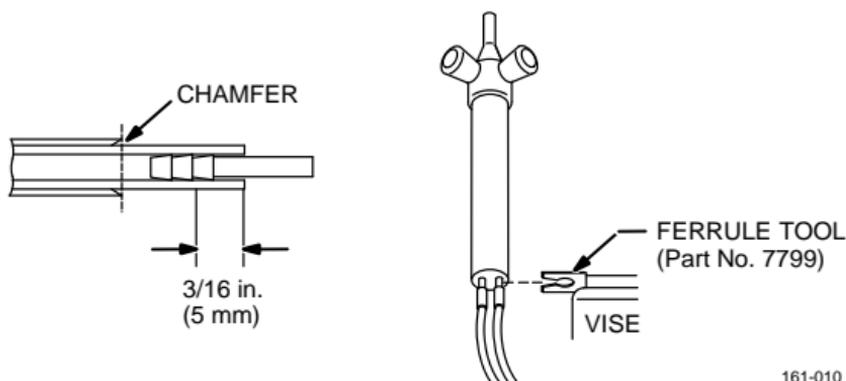

161-010

Figure 4. Hose Replacement

3. Push metal ferrule onto barbed nipple. Slip hose into ferrule tool below ferrule and slide tool against end of ferrule.
4. Hold torch so that ferrule tool is resting on top of vise. Open vice jaws to approximate width of hose. Using a plastic hammer, wood block, or equivalent, tap lightly on end of tubing or socket until the metal ferrule just covers the barbs of the nipples. Remove tool.

5. Repeat instructions for red hose.
- ⚠ Use an approved oil-free leak detection fluid to locate possible leaks.**
6. Close torch valves and pressurize torch (both hoses) to 10–12 psig (69–83 kPa). Immerse torch in water and check connections and torch for leaks (bubbles). If a leak is not observed, the torch is now ready to use. If leaks are detected, eliminate them before proceeding. If leaks cannot be eliminated, do not put the equipment into service until it has been repaired or replaced.

SECTION 10 – REGULATORS



The following regulators are recommended for use with the torch because they provide the low regulated pressures and flows necessary for fine flame adjustment and stability.

Stock No.	Gas	Inlet Connection	Fits Cylinders
30-20-540	Oxygen	CGA 540	All Industrial Oxygen
30-15-520	Acetylene	CGA 520	Type B And Autolite
30-15-300	Acetylene	CGA 300	Commercial Acetylene
30-15-510	Acetylene	CGA 510	Commercial Acetylene
30-15-200	Acetylene	CGA 200	"MC" (10 Cubic Ft)
30-15-510	LP*	CGA 510	POL
30-100-350	Hydrogen	CGA 350	Hydrogen

* Propane or propylene-based fuels.

SECTION 11 – TECHNICAL DATA



11-1. Tip Specifications

A. Straight, Curved, And Twin-Flame Torch Tips

Tip Size	Orifice Diameter in. (mm)	Gas Pressure psig (kPa)		Consumption Each Gas* ft ³ /hr (L/hr)	Recom'd Fuel Gas w/Oxygen
		Oxygen	Fuel		
2	.006 (0.15)	2 (13.8)	2 (13.8)	0.11074 (3.1)	Acetylene, Hydrogen
3	.011 (0.28)	4 (27.6)	4 (27.6)	0.94 (26.6)	Acetylene, Hydrogen, Propane, Propylene, Natural Gas, City Gas
4	.020 (0.5)	5 (34.5)	5 (34.5)	1.88 (53.2)	
5	.029 (0.73)	6 (41.4)	6 (41.4)	3.1 (87.8)	
6	.037 (0.94)	6 (41.4)	6 (41.4)	5.38 (152)	
7	.047 (1.19)	8 (55.2)	8 (55.2)	7.52 (213)	

* Acetylene and oxygen only.

Pressures above apply to all fuel gases.

B. Multi-Orifice Heating Tip Specifications

Model No.	Gas Pressure psig (kPa)		Consumption ft ³ /hr (L/hr)		BTU Output	Recom'd Fuel Gases
	Oxygen	Fuel	Oxygen	Fuel		
13662	14 (95.5)	10 (69)	5.51 (156)	4.58 (129.7)	7050	Acetylene, Hydrogen, Propylene
13717	14 (95.5)	10 (69)	12.8 (362)	5.12 (145)	5000	Propane
13717	7 (48.3)	5 (34.5)	3.6 (102)	2.2 (62.3)	2400	Natural Gas

11-2. Fuel Gas And Flame Characteristics

Settings: Neutral Flame

Acetylene – Oxygen

After igniting, open acetylene valve until soot disappears from end of flame. Add oxygen until the feather shown on the right just disappears in the bright inner cone.

Propane – Oxygen

After igniting, add oxygen until bright inner core reaches its shortest point and then stop. Repeat process to force as much fuel through the tip as possible.

Flame Settings

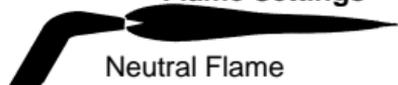

Neutral Flame

Even Mixture of Fuel and Oxygen

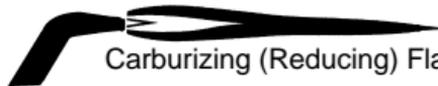

Carburizing (Reducing) Flame

Excess Fuel Gas

- Lower Temperature
- Less Oxidizing

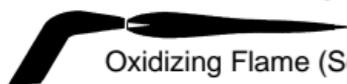

Oxidizing Flame (Seldom Used)

Excess Oxygen

- Short Outer Flame
- Narrow Inner Cone
- Noisy
- Hottest

11-3. Flame And Heat Placement BTU Output Per Cubic Ft Of Fuel Burned With Oxygen

Fuel Gas	Total BTU Output ft ³ Gas/hr (L Gas/hr)	Flame Temperatures In °F (°C)			Oxygen To Fuel Ratio
		Compressed Air Tips	Atmospheric Air Tips	Oxygen	
<p>Acetylene</p>	1470 (41,626)	4800 (2649)	1500 (816)	6000 (3316)	25:1
<p>Propane</p>	2500 (70,792)	3500 (1927)	1500 (816)	4800 (2649)	5:1
<p>Natural Gas (City Gas)</p>	911 (25,797)	3400 (1871)	—	4600 (2538)	2:1
<p>Hydrogen</p>	325 (9203)	4000 (2204)	—	4800 (2649)	5:1

11-4. Cylinder Valve Identification For Regulator Selection

Compressed Gas Association connection numbers are also shown.

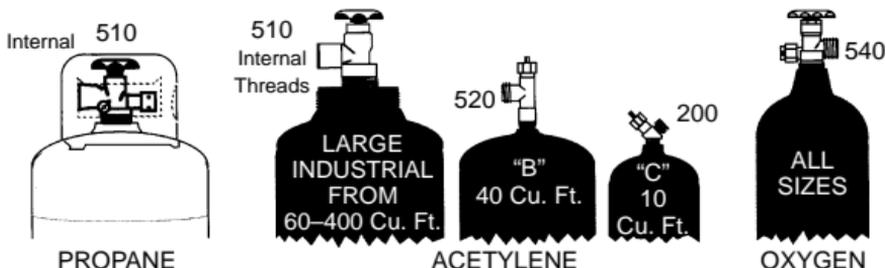

SECTION 12 – ACCESSORIES



Straight Tip

Size 4



Twin Flame Tip

Sizes 4–6

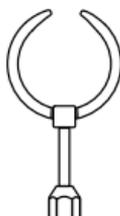

Propane/Natural Gas Melting Tip

Melts To 3 oz. Silver

Stock No. 13717

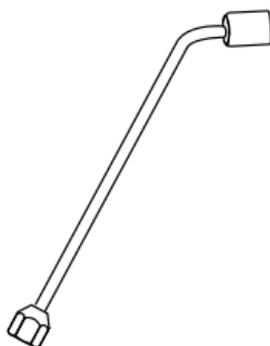

Acetylene/Hydrogen Melting Tip

Melts to 3 oz. Gold Or Silver

Stock No. 13-662

Curved Tips

Sizes 2–7



Magnetic Stand

Stock No. 14014

Torch And Tips Sold Separately
Size 2–3 Tips Have Jeweled Orifice

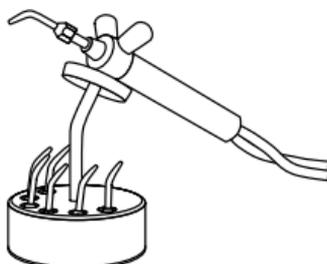



Effective July 1, 2013

**(For Oxy-Fuel and Pressure Regulation Equipment
with a date code of BDG or newer)**

This limited warranty supersedes all previous Miller warranties and is exclusive with no other guarantees or warranties expressed or implied.

LIMITED WARRANTY - Subject to the terms and conditions below, Miller Electric Mfg. Co., Appleton, Wisconsin, warrants to its original retail purchaser that new Miller equipment sold after the effective date of this limited warranty is free of defects in material and workmanship at the time it is shipped by Miller. THIS WARRANTY IS EXPRESSLY IN LIEU OF ALL OTHER WARRANTIES, EXPRESS OR IMPLIED, INCLUDING THE WARRANTIES OF MERCHANTABILITY AND FITNESS. Within the warranty periods listed below, Miller will repair or replace any warranted parts or components that fail due to such defects in material or workmanship. Miller must be notified in writing within thirty (30) days of such defect or failure, at which time Miller will provide instructions on the warranty claim procedures to be followed. Miller shall honor warranty claims on warranted equipment listed below in the event of such a failure within the warranty time periods. All warranty time periods start on the delivery date of the equipment to the original end-user purchaser, and not to exceed one year after the equipment is shipped to a North American distributor or eighteen months after the equipment is shipped to an International distributor.

1. Lifetime Warranty – Parts and Labor
 - * Torch Handles, Cutting Attachments, Straight Cutting Torches and Machine Torches stamped with a "LIFETIME" inscription. The use of tips other than genuine Miller tips may void the lifetime warranty.
2. 3 Years – Parts and Labor
 - * Toughcut Outfits, Series 30, 32, 35, 36, 40, 46 Regulators, and all Flowmeters, Flow Gauges, and Flowmeter Regulators
3. 2 Years – Parts and Labor
 - * Series 250, 820, and Smith-Branded Specialty Gas Regulators
4. 1 Year – Parts and Labor
 - * Gas Axe Cutting Torches, HVAC/Purge Regulators, 3-Stage Nitrogen Low-Pressure Blanketing Regulators, Gas Savers, Gas Mixers, and all other Oxy-Fuel Products
 - * SMITH BRANDED PRODUCTS
The Little Torch, Quickbraze Torch, Handi-Heat/Silver Smith Torch
5. 90 Days – Parts and Labor
 - * Corrosive Service Regulators

Miller's True Blue® Limited Warranty shall not apply to:

1. Consumable components; oxy-fuel cutting, welding, and heating tips, or parts that fail due to normal wear.
2. Items furnished by Miller, but manufactured by others. These items are covered by the manufacturer's warranty, if any.
3. Equipment that has been modified by any party other than Miller, or equipment that has been improperly installed, improperly operated or misused based upon industry standards, or equipment which has not had reasonable and necessary maintenance, or equipment which has been used for operation outside of the specifications for the equipment.

MILLER PRODUCTS ARE INTENDED FOR PURCHASE AND USE BY COMMERCIAL/INDUSTRIAL USERS AND PERSONS TRAINED AND EXPERIENCED IN THE USE AND MAINTENANCE OF WELDING EQUIPMENT. In the event of a warranty claim covered by this warranty, the exclusive remedies shall be, at Miller's option: (1) repair; or (2) replacement; or, where

authorized in writing by Miller in appropriate cases, (3) the reasonable cost of repair or replacement at an authorized Miller service station; or (4) payment of or credit for the purchase price (less reasonable depreciation based upon actual use) upon return of the goods at customer's risk and expense. Miller's option of repair or replacement will be F.O.B., Factory at Appleton, Wisconsin, or F.O.B. at a Miller authorized service facility as determined by Miller. Therefore no compensation or reimbursement for transportation costs of any kind will be allowed. TO THE EXTENT PERMITTED BY LAW, THE REMEDIES PROVIDED HEREIN ARE THE SOLE AND EXCLUSIVE REMEDIES. IN NO EVENT SHALL MILLER BE LIABLE FOR DIRECT, INDIRECT, SPECIAL, INCIDENTAL OR CONSEQUENTIAL DAMAGES (INCLUDING LOSS OF PROFIT), WHETHER BASED ON CONTRACT, TORT OR ANY OTHER LEGAL THEORY. ANY EXPRESS WARRANTY NOT PROVIDED HEREIN AND ANY IMPLIED WARRANTY, GUARANTY OR REPRESENTATION AS TO PERFORMANCE, AND ANY REMEDY FOR BREACH OF CONTRACT TORT OR ANY OTHER LEGAL THEORY WHICH, BUT FOR THIS PROVISION, MIGHT ARISE BY IMPLICATION, OPERATION OF LAW, CUSTOM OF TRADE OR COURSE OF DEALING, INCLUDING ANY IMPLIED WARRANTY OF MERCHANTABILITY OR FITNESS FOR PARTICULAR PURPOSE, WITH RESPECT TO ANY AND ALL EQUIPMENT FURNISHED BY MILLER IS EXCLUDED AND DISCLAIMED BY MILLER.

Some states in the U.S.A. do not allow limitations of how long an implied warranty lasts, or the exclusion of incidental, indirect, special or consequential damages, so the above limitation or exclusion may not apply to you. This warranty provides specific legal rights, and other rights may be available, but may vary from state to state. In Canada, legislation in some provinces provides for certain additional warranties or remedies other than as stated herein, and to the extent that they may not be waived, the limitations and exclusions set out above may not apply. This Limited Warranty provides specific legal rights, and other rights may be available, but may vary from province to province.

Mil oxy-fuel warr 2013-05



SMITH
EQUIPMENT

Miller Electric Mfg. Co.

An Illinois Tool Works Company
1635 West Spencer Street
Appleton, WI 54914 USA

International Headquarters—USA

USA Phone: 920-735-4505 Auto-Attended
USA & Canada FAX: 920-735-4134
International FAX: 920-735-4125

For International Locations Visit
www.MillerWelds.com